

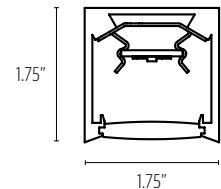

Stealth™ Acoustic

TUNABLE WHITE/RGBW PENDANT



PROFILE VIEW

FEATURES

- 0.36" (9MM) ACOUSTIC PANEL MITIGATES SOUND REVERBERATION
- UNIQUE ETCHED PANEL DESIGN HIDES SEAM IN LARGER SIZES
- 1.75" MINIMAL SQUARE PROFILE SIZE
- SILICONE DIFFUSER ELIMINATES LIGHT LEAKS AND VISIBLE SEAMS
- FIELD REPLACEABLE LED ARRAYS AND DRIVER(S) FOR SIMPLE MAINTENANCE
- FIXTURES CAN BE CLUSTERED TOGETHER TO CREATE LARGE SCALE INSTALLATIONS
- CUSTOM SIZES, SHAPES, AND CONFIGURATIONS ARE POSSIBLE - REFER TO REV SHAPES SPEC SHEET FOR DETAILS



CATALOG CODES

A	B	C	MW	E	F	UNV	H	DM1	J
SERIES	HANGING SYSTEM	SIZE	DIFFUSER	FINISH	LIGHT SOURCE	VOLTAGE	OAH	CONTROL	OPTIONS

SPECIFY CATALOG CODE				
A	B	C	D	E
SERIES	HANGING SYSTEM	SIZE	DIFFUSER	FINISH
SE1 STEALTH INNER SE2 STEALTH OUTER SE3 STEALTH DOWN	PIEM PENDANT WITH VERTICAL AIRCRAFT CABLES TO SEPARATE MOUNTING POINTS AND POWER CORD TO CANOPY; MOUNTS TO 4X4 OCTAGON J-BOX (BY OTHERS); REMOTE DRIVER ENCLOSURE PISC PENDANT WITH ANGLED AIRCRAFT CABLES AND POWER CORD TO SQUARE CANOPY; MOUNTS TO 4X4 OCTAGON J-BOX (BY OTHERS); REMOTE DRIVER ENCLOSURE	FLAT ACOUSTIC PANEL 24 36 48	ETCHED ACOUSTIC PANEL 24EP 36EP 48EP 60EP 72EP	MW MATTE WHITE POWDER COAT FINISHES BKP BLACK BMP BRASS METALLIC BNP BRONZE BTP BLACK TEXTURED GRP GRAPHITE GLP GOLDTASTIC MWP MATTE WHITE SGP STEEL GRAY SMP SILVER METALLIC SWP SKY WHITE WTP WHITE TEXTURED PREMIUM METAL FINISHES BAL BRUSHED ALUMINUM

F		G	H	I	J
LIGHT SOURCE		VOLTAGE	OAH*	CONTROL	OPTIONS
LED OUTPUT TWH1 COLOR TEMP TUNABLE WHITE 2700K - 6500K CRI=90+ R9=50+	RGBW RGBW	UNV 120-277	48 100 144	DM8 DUAL 0-10V DIMMABLE TO 0.1% DALI DALI TYPE 8 CONTROL SYSTEM, DIMMABLE TO 0.1% DMX DMX CONTROL; DIMMABLE TO 0.1%	MOD MODIFIED LUMINAIRE (CONTACT LOCAL REP) ACOUSTIC COLORS PBK PURE BLACK CHG CHARCOAL SLT SLATE SDG SHADOW GRAY PIC PEARL ICE CWH CLASSIC WHITE SLG SILVER GRAY NTL NATURAL LINEN HZW HAZELWOOD DNB CORNFLOWER BLUE CFB DENIM BLUE BRD BRICK RED MNB MIDNIGHT BLUE DPP DEEP PURPLE BRY BERRY CHR CHERRY RED CRT CARROT DWT DEEPWATER PNA PINEAPPLE LMS LIMESTONE EMG EMERALD GREEN BLS BLUSH SFM SEAFOAM

SAMPLE CODE: SE1-PIEM-36-MW-WTP-TWH1-UNV-100-DM8-PBK

*Ships with one of three OAH's (48", 100" or 144") and is field adjustable to the desired height
 Fixtures with **PIEM** hanging system, canopy will be MWP unless specified.
 Fixtures with **PISC** hanging system, canopy will match finish choice.
 Power cord silver unless specified.

MODS, NOTES, & COMMENTS

PIEM PENDANT WITH VERTICAL AIRCRAFT CABLES TO SEPARATE MOUNTING POINTS AND POWER CORD TO CANOPY; MOUNTS TO 4X4 OCTAGON J-BOX (BY OTHERS); REMOTE DRIVER ENCLOSURE

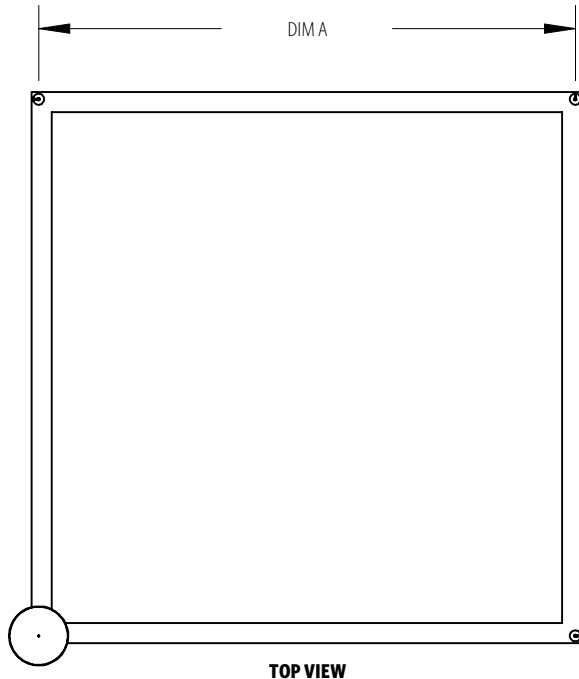
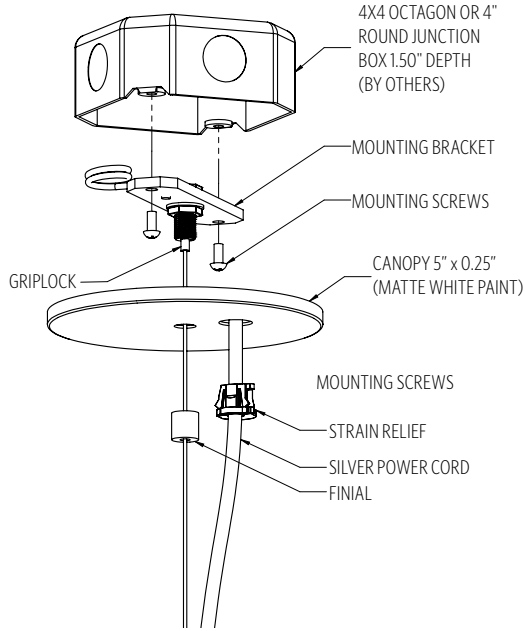
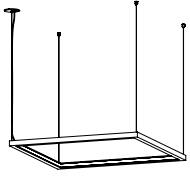

TUNABLE WHITE MOUNTING INFORMATION CHART

LUMINAIRE SIZE	LUMINAIRE WEIGHT	SE1 MOUNTING DISTANCE DIM A	SE2 MOUNTING DISTANCE DIM A	SE3 MOUNTING DISTANCE DIM A	MOUNTING POINTS	MIN/MAX OAH
24"	7 LBS	22.375	21.25	22.063	4	5"/144"
36"	12 LBS	34.375	33.25	34.063	4	5"/144"
48"	18 LBS	46.375	45.25	46.063	4	5"/144"
60"	22 LBS	58.375	57.25	58.063	4	5"/144"
72"	26 LBS	70.375	69.25	70.063	4	5"/144"

RGBW MOUNTING INFORMATION CHART

LUMINAIRE SIZE	LUMINAIRE WEIGHT	SE1 MOUNTING DISTANCE DIM A	SE2 MOUNTING DISTANCE DIM A	SE3 MOUNTING DISTANCE DIM A	MOUNTING POINTS	MIN/MAX OAH
24"	7 LBS	20.188	18.938	19.75	4	5"/144"
36"	12 LBS	32	30.75	31.563	4	5"/144"
48"	18 LBS	43.813	42.563	43.375	4	5"/144"
60"	22 LBS	55.563	54.375	55.188	4	5"/144"
72"	26 LBS	67.438	66.188	67	4	5"/144"

PIEM ships with one of three OAH's (48", 100" or 144") and is field adjustable to the desired height. For OAH over 144", contact your local rep

PIEM will include ETL listed enclosure for remote mounting drivers. For **TWH1** and **RGBW** remote box distance, refer to the chart below

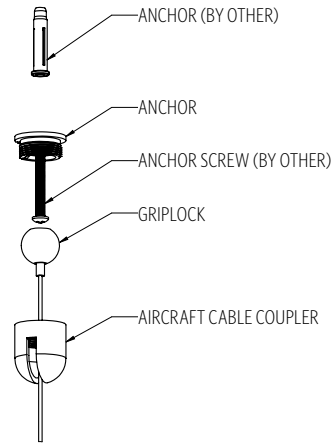

HARD CEILING

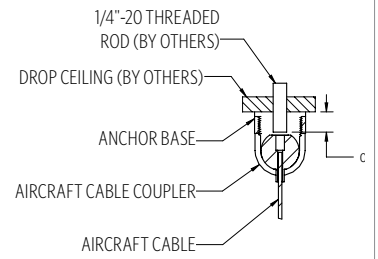

DROP CEILING

REMOTE DRIVER HOUSING ENCLOSURE (PROVIDED BY OCL)

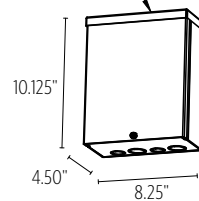

MAX WIRE LENGTH FROM DRIVER REMOTE BOX TO LUMINAIRE

AWG* VALUE	20	10	18	17	16
DISTANCE (m)	14	18	22	28	36
DISTANCE (ft)	46	59	72	92	118

*American Wire Gauge (AWG) is the standard way to denote cross-directional diameter of individual wire in North America.

Please observe voltage drops over long wire length; Longer wire lengths increase EMI susceptibility.

HANGING SYSTEM

PISC PENDANT WITH ANGLED AIRCRAFT CABLES AND POWER CORD TO SQUARE CANOPY; MOUNTS TO 4X4 OCTAGON J-BOX (BY OTHERS); REMOTE DRIVER ENCLOSURE

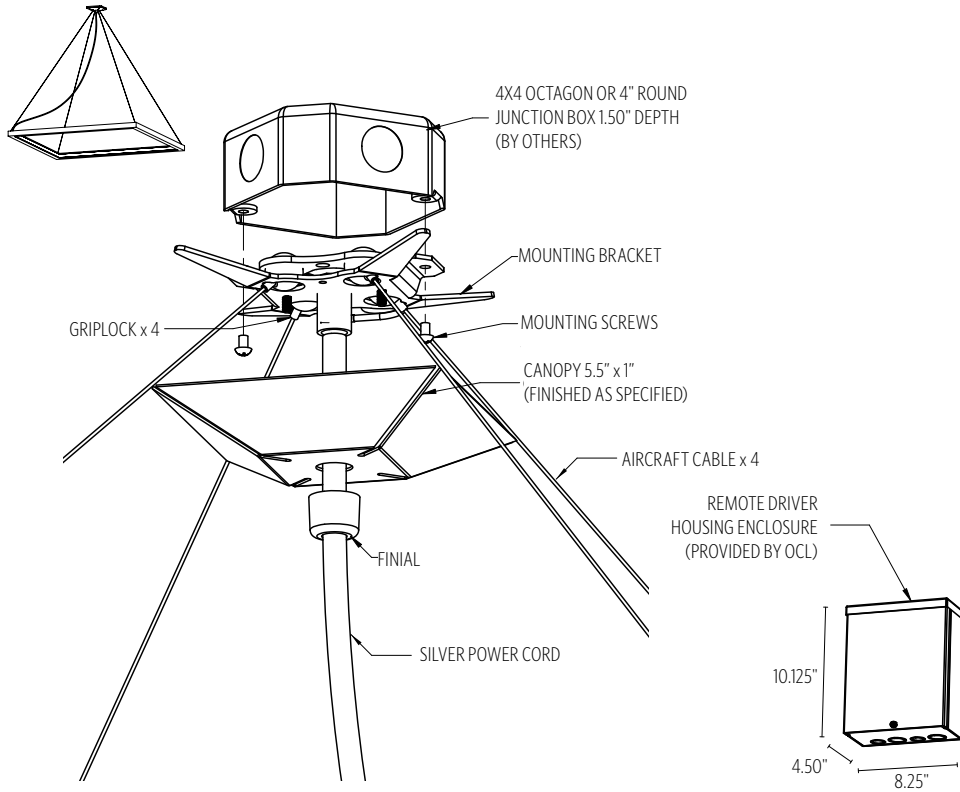

MOUNTING INFORMATION CHART

LUMINAIRE SIZE	LUMINAIRE WEIGHT	MOUNTING POINTS	MIN/MAX OAH
24"	12 LBS	1	10"/144"
36"	14 LBS	1	12"/144"
48"	16 LBS	1	19"/144"
60"	18 LBS	1	38"/144"
72"	21 LBS	1	46"/144"

PISC ships with one of three OAH's (48", 100" or 144") and is field adjustable to the desired height. **PISC** will include ETL listed enclosure for remote mounting drivers. Max 30' distance from luminaire for **DM8**, **DALI** or **DMX**. Enclosure must remain accessible after installation. For **RGBW** remote box distance, contact factory

MAX WIRE LENGTH FROM DRIVER REMOTE BOX TO LUMINAIRE

AWG* VALUE	20	10	18	17	16
DISTANCE (m)	14	18	22	28	36
DISTANCE (ft)	46	59	72	92	118

*American Wire Gauge (AWG) is the standard way to denote cross-directional diameter of individual wire in North America.

Please observe voltage drops over long wire length; Longer wire lengths increase EMI susceptibility.

SIZES

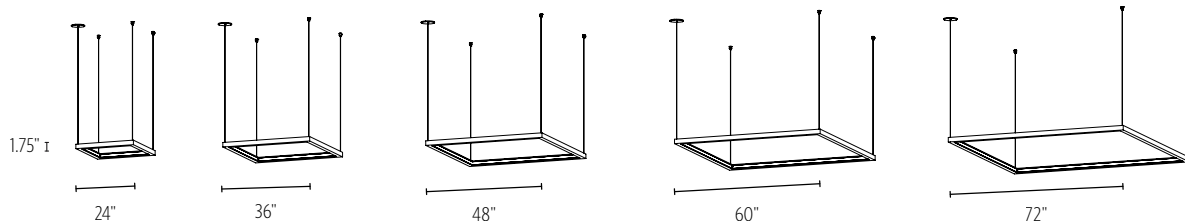

DIFFUSER



MW MATTE WHITE

METALLIC POWDER COAT FINISHES:



SMP
SILVER



GRP
GRAPHITE



SGP
STEEL GRAY



GLP
GOLDTASTIC



BMP
BRASS



BNP
BRONZE

PREMIUM METAL FINISHES:



BAL
BRUSHED ALUMINUM

SOLID POWDER COAT FINISHES:



SWP
SKY WHITE



MWP
MATTE WHITE



BKP
BLACK

TEXTURED POWDER COAT FINISHES:



BTP
BLACK TEXTURED



WTP
WHITE TEXTURED

RAL, **Pantone**® or custom finishes are also available.

These colors are for reference only. Please be aware that colors may vary per monitor. Contact your local rep for finish samples or with any questions.

ACOUSTIC

ACOUSTIC COLORS:



ABOUT OUR ACOUSTIC PANELS

Flat and Etched acoustic available up to 48" as single panel with no seam. Etched acoustic available in 60" or 72" panels as two panels with center seam hidden within etched pattern and additional bracketry hardware finished as specified (shown below).

NOTE: Visibility of seams & etching can vary by color selection.



FLAT PANEL



ETCHED PANEL

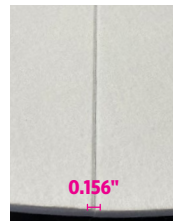

SEAM DETAIL

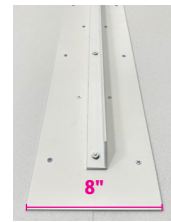

HARDWARE DETAIL
(60" & 72" ONLY)

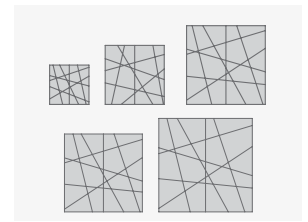

PATTERN DETAIL

LIGHT SOURCE

		SE1					SE2					SE3				
		24"	36"	48"	60"	72"	24"	36"	48"	60"	72"	24"	36"	48"	60"	72"
TWH1	LUMENS DELIVERED	-	-	-	-	-	LUMEN & WATTAGE DATA PENDING TESTING									
	SYSTEM WATTAGE	17	27	36	45	54										
RGBW	LUMENS DELIVERED	272	424	568	720	872										
	SYSTEM WATTAGE	34	53	71	90	109										

Wattage and lumen data for **TWH1** and **RGBW** approx. pending LM-79 testing.

PHOTOMETRY:

LUMINAIRE: SE1-PIEM-48-MW-PTD-LED2_35K-UNV-48
 COLOR TEMP #: 3500K
 TEST REPORT: TEST NO. 20860.0; 20861.0; 20862.0

STANDARD COLOR TEMPERATURE OPTIONS	CRI (RA)
TWH1	90+
RGBW	N/A

For 90+ CRI - 90 RA, R9 > 50

% OF LUMINAIRE	
ZONE	SE1 AC
0-30	12%
0-60	52%
0-90	100%
90-180	0%
0-180	100%

For all available IES files, please visit our website at ocl.com.

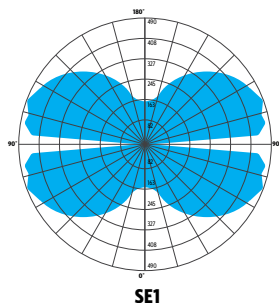

ACOUSTICAL TESTING

STEALTH ACOUSTIC PERFORMANCE (4 UNITS):

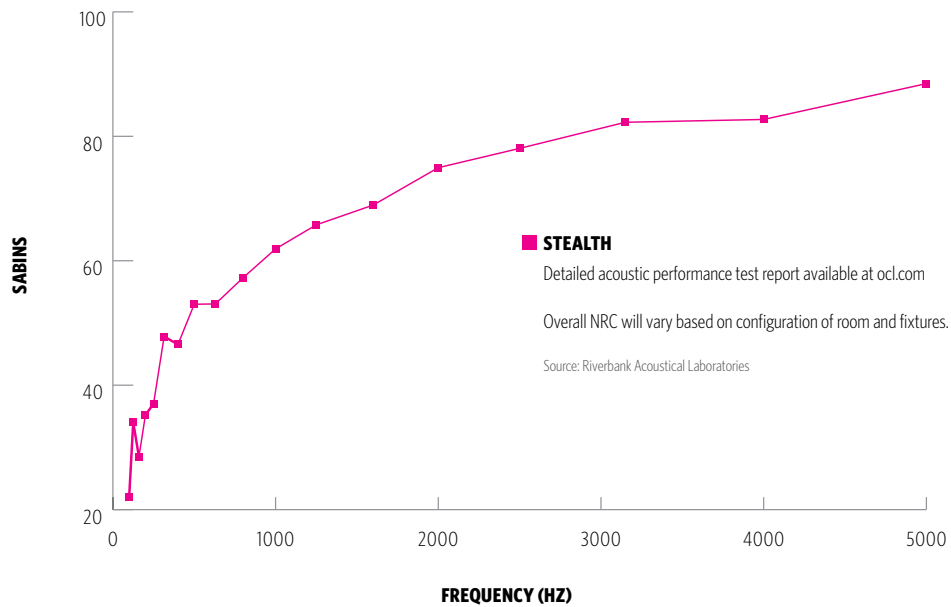

CONTROL

DALI DALI CONTROL SYSTEM, DIMMABLE 0.1%

- DALI-2 DEVICE TYPE 6 CONTROL PROTOCOL
- 0.1% MINIMUM DIM LEVEL
- ELECTRONIC DRIVER
- POWER FACTOR >0.9
- THD <20%
- MINIMUM AMBIENT OPERATING TEMPERATURE -4°F
- LOGARITHMIC DIMMING CURVE [DEFAULT]
- FIELD REPLACEABLE

DMX DMX CONTROL DIMMABLE TO 0.1%

- DMX/RDM DIMMING PROTOCOL
- 0.1% MINIMUM DIM LEVEL
- ELECTRONIC DRIVER
- POWER FACTOR >0.9
- THD <20%
- MINIMUM AMBIENT OPERATING TEMPERATURE -4°F
- LOGARITHMIC DIMMING CURVE [DEFAULT]
- FIELD REPLACEABLE

DM8 DUAL 0-10V DIMMING 0.1%

- 0-10V DIMMING PROTOCOL
- 0.1% MINIMUM DIM LEVEL
- ELECTRONIC DRIVER
- POWER FACTOR >0.9
- THD <20%
- MINIMUM AMBIENT OPERATING TEMPERATURE -4°F
- LOGARITHMIC DIMMING CURVE [DEFAULT]
- FIELD REPLACEABLE

OPTIONS

MOD MODIFIED LUMINAIRE

- LUMINAIRE IS MODIFIED FROM STANDARD OPTIONS; CONTACT LOCAL REP FOR MORE INFORMATION

ACOUSTIC PANEL

- AFFIXED ACOUSTIC PANEL AIDS IN THE REDUCTION OF SOUND REFLECTIONS, REVERBERATION, AND ECHO
- ASTM E-84 CLASS A / CAN ULC S102 FLAME SPREAD: 0 | SMOKE DEVELOPMENT INDEX: 300
- 0.36" (9MM) 100% POLYESTER FIBER PANEL WITH A MINIMUM 50% POST-CONSUMER RECYCLED MATERIAL (PET)
- ACOUSTIC PERFORMANCE (ASTM C423) TEST REPORT AVAILABLE AT OCL.COM
- VARIATIONS IN FIBER MIX AND COLOR MAY OCCUR. ALL PRODUCTS WILL BE SUPPLIED WITHIN COMMERCIAL TOLERANCES
- **CARE & CLEANING:** REMOVE DUST AND DEBRIS WITH A CLEAN, SOFT, LINT-FREE CLOTH OR VACUUM



SPECIFICATIONS

CONSTRUCTION

- HOUSING IS EXTRUDED AND WELDED ALUMINUM
- HOUSING CORNERS ARE FULLY WELDED AND GROUND SMOOTH
- DIFFUSER IS EXTRUDED SILICONE
- CANOPY IS FORMED ALUMINUM
- HARDWARE IS ZINC PLATED OR STAINLESS STEEL

MOUNTING

- **PI3C** AND **PIEM** ALL MOUNT TO 4X4" OCTAGON OR 4" ROUND J-BOX (BY OTHER)

ELECTRICAL

- DIMMING ELECTRONIC DRIVER(S), COMES STANDARD WITH 0-10V DOWN TO 1% (STATIC WHITE)
- OCL PROPRIETARY LED ARRAYS USE NICHIA 757 DIODES (STATIC WHITE)
- **FOR INTEGRAL DRIVERS:** LUMINAIRE CONNECTS TO BUILDING SUPPLY (120V-277V 50/60HZ)
- **FOR REMOTE DRIVERS:** LUMINAIRE WIRE LEADS ARE LOW-VOLTAGE. THE WIRES SHOULD BE CONNECTED TO OCL PROVIDED REMOTE DRIVER ENCLOSURE ONLY!

LISTING

- ETL LISTED TO UL 1598/2108 FOR DRY LOCATIONS, DAMP LOCATION LISTED IS OPTION

WARRANTY

- 5 YEAR; ALL ELECTRICAL COMPONENTS RETAIN THE MANUFACTURER'S WARRANTY

SUSTAINABILITY

- THIS PRODUCT MEETS THE MATERIAL RESTRICTIONS OF ARTICLE 4 OF THE **ROHS** DIRECTIVE (2011/65/EU), INCLUDING COMMISSION DELEGATED DIRECTIVE 2015/863

COMMON MODIFICATIONS

WE'RE BUILT FOR OUT-OF-THE-BOX THINKERS.

Nearly 50% of OCL fixtures we manufacture have some type of modification. Here is a list of common modifications we frequently produce. **Please contact the factory for modifications specific to your fixture or project.**

Need some help? Simply send your questions to us at OCL-Quotes@ocl.com

- BIOS, TUNABLE WHITE, WARM-DIM, & RGBW LIGHT SOURCES
- SPECIFIC LUMEN OUTPUT
- MODIFIED CLUSTERS OR CONFIGURATIONS / MULTI-DROP CANOPIES
- VARIOUS SHAPES, ARCS, AND CURVES FOR LINEAR PROFILES AND RINGS
- CEILING OR SURFACE MOUNTING
- LARGE SCALE MODIFICATIONS
- RAL, PANTONE, BRAND-SPECIFIC, RETIRED OCL COLOR, OR CUSTOM FINISHES



- EMERGENCY BATTERY BACKUP OR INVERTER OPTIONS
- REMOTE DRIVERS / EXTENDED DISTANCE REMOTE DRIVERS
- DIMMING TO 0.1% (DIM TO DARK)
- NON-STANDARD SIZES OR LENGTHS
- NON-STANDARD CANOPY, BODY AND/OR CORD COLORS
- SEISMIC AND/OR ANTI-SWAY SYSTEMS
- RIGID STEMS
- MODIFIED OVERALL HEIGHTS (LONGER OR SHORTER OAH)
- UPLIGHT ADDITIONS
- LASER ETCHING, ENGRAVING, AND CUTOUTS

The drawings and specifications and ideas, designs and arrangements represented on these drawings are and shall remain the property of The Original Cast Lighting (OCL Architectural Lighting) and no part thereof shall be copied, disclosed, to others or used in conjunction with any work or project other than the specified project for which they have been prepared and developed, without written consent of OCL. Visual contact with these plans or specifications shall constitute conclusive evidence of acceptance of these restrictions. All specifications and information subject to change without notice.