



Una™

CEILING

FEATURES

- SIMPLE, LINEAR 3"W X 3.5"H PROFILE CAN BE CONNECTED TO CREATE LONG, CONTINUOUS RUNS
- FIELD REPLACEMENT OF LED ARRAYS AND DRIVERS IS SIMPLE AND REQUIRES MINIMAL EFFORT
- QUALITY CONSTRUCTION INCLUDES HEAVY GAUGE SHEET METAL, EXTRUDED ALUMINUM, DIE-CAST ALUMINUM, AND EXTRUDED ACRYLIC
- EXTRUDED DIFFUSER IS FROSTED WHITE ACRYLIC, UV STABLE AND UL-94 HB FLAME RATED
- 3 STEP COLOR BINNING



CATALOG CODES

UA1	-	C1NA	-	C	-	MW	-	E	-	f	-	UNV	-	DM1	-	I
SERIES		HANGING SYSTEM		SIZE		DIFFUSER		FINISH		LIGHT SOURCE		VOLTAGE		CONTROL		OPTIONS

SPECIFY CATALOG CODE						
A	B		C	D	E	
SERIES	HANGING SYSTEM		SIZE	DIFFUSER	STANDARD FINISHES	PREMIUM FINISHES
 UA1 UNA	C1NA	SURFACE CEILING MOUNT	24 36 48 60 89 XX	MW MATTE WHITE	POWDER COAT FINISHES BKP BLACK BMP BRASS METALLIC BNP BRONZE BTP BLACK TEXTURED GRP GRAPHITE GLP GOLDTASTIC MWP MATTE WHITE SGP STEEL GRAY SMP SILVER METALLIC SWP SKY WHITE WTP WHITE TEXTURED	METAL FINISHES BAL BRUSHED ALUMINUM EVERWOODS POWDER COAT FINISHES WPDP WHITE PINE PNDP PINE CRDP CHERRY TKDP TEAK WLDP WALNUT DLDP DARK WALNUT LWDP LIGHT BARNWOOD DWDP DARK BARNWOOD
F		G		H		I
LIGHT SOURCE		VOLTAGE		CONTROL		OPTIONS
LED OUTPUT LED1 LED2	COLOR TEMP (80+ CRI) 27K 30K 35K 40K	COLOR TEMP (90+ CRI) 927K 930K 935K 940K	UNV 120-277	DM1 0-10V DIMMING 1%		ULD DAMP LABEL BIOS BIOS SKYBLUE™ OR BIOS SKYBLUE™ DYNAMIC LIGHT ENGINE** MOD MODIFIED LUMINAIRE (CONTACT LOCAL REP)

SAMPLE CODE: UA1-C1NA-24-MW-WTP-LED1/27K-UNV-DM1

*For a modified length, type in length of fixture in inches to the nearest 0.0625"; Min. 24
 Contact factory for **BIOS SkyBlue® or **BIOS SkyBlue® Dynamic** light engine and control options. Visit ocl.com/BIOS for more information.

MODS, NOTES, & COMMENTS

UP TO **80** LM/W

		LUMENS AND WATTAGE CHART				
		24"	36"	48"	60"	89"
LED1	LUMENS DELIVERED	1120	1680	2240	2800	4080
	SYSTEM WATTAGE	14	21	28	35	51
LED2	LUMENS DELIVERED	1680	2480	3360	4160	6160
	SYSTEM WATTAGE	21	31	42	52	77

This chart was created for a 35K color temp. Multiply by 0.95 for 27k color temp, 0.97 for 30k color temp, and 1.03 for 40k color temp.

Values shown for 80+ CRI. For 90+ CRI lumens use 0.85 multiplier.

HANGING SYSTEM



CINA SURFACE CEILING MOUNT

MOUNTING INFORMATION CHART

LUMINAIRE SIZE	LUMINAIRE WEIGHT	MOUNTING DISTANCE DIM A	MOUNTING POINTS
24.25"	6.5 LBS	21.00"	2
36.25"	9 LBS	33.00"	2
48.25"	11.5 LBS	45.00"	2
60.25"	14 LBS	57.00"	2
89.25"	20 LBS	86.00"	2

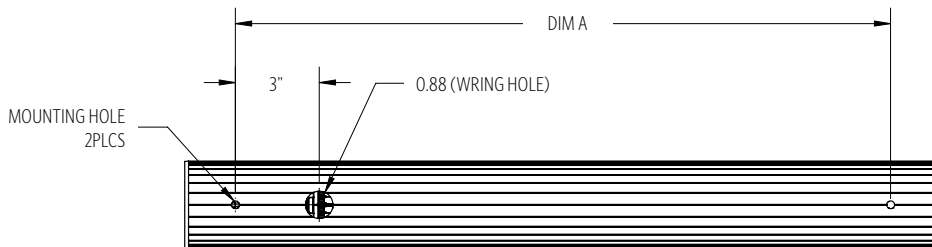
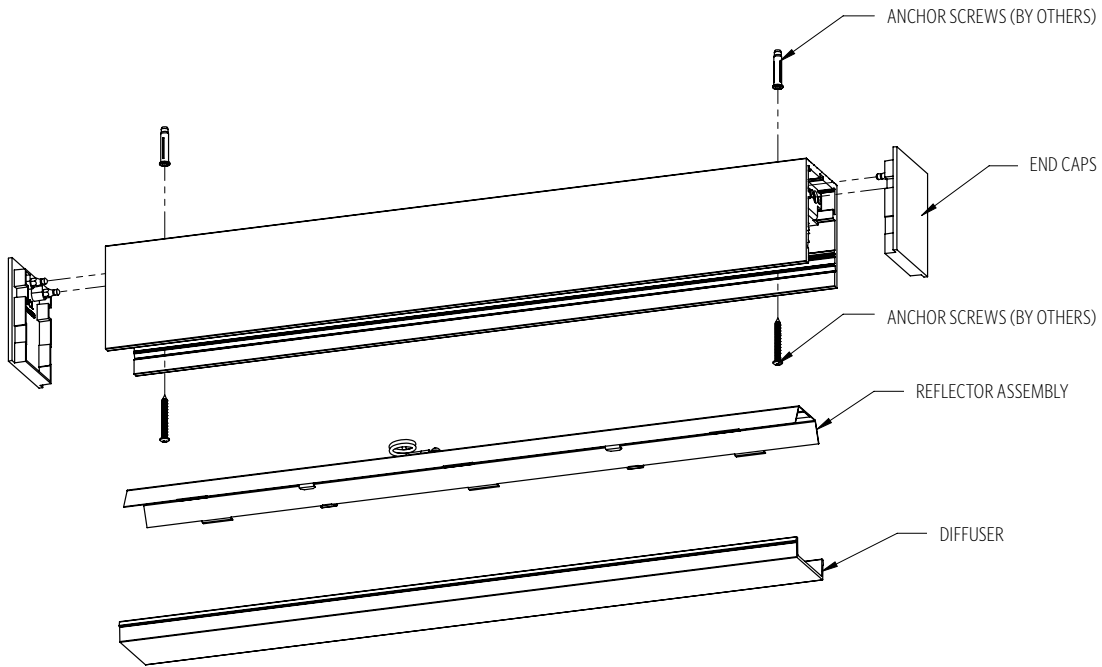

SIZES

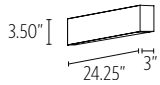

WT. 6.5 LBS

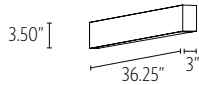

WT. 9 LBS

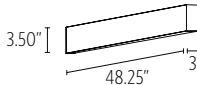

WT. 11.5 LBS

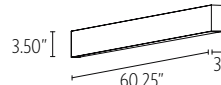

WT. 14 LBS

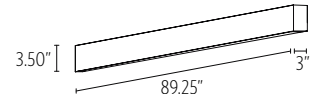

WT. 20 LBS

DIFFUSER



MW MATTE WHITE

FINISH

METALLIC POWDER COAT FINISHES:



SMP
SILVER



GRP
GRAPHITE



SGP
STEEL GRAY



GLP
GOLD



BMP
BRASS



BNP
BRONZE

PREMIUM METAL FINISHES:



BAL
BRUSHED
ALUMINUM

SOLID POWDER COAT FINISHES:



SWP
SKY WHITE



MWP
MATTE
WHITE



BKP
BLACK



BTP
BLACK
TEXTURED



WTP
WHITE
TEXTURED

RAL®, Pantone® or custom finishes are also available.

These colors are for reference only. Please be aware that colors may vary per monitor. Contact your local rep for finish samples or with any questions.

EVERWOODS POWDER COAT COLLECTION:



WPDP
WHITE PINE



PNDP
PINE



CRDP
CHERRY



TKDP
TEAK



WLDP
WALNUT



DLDP
DARK
WALNUT



LWDP
LIGHT
BARNWOOD



DWDP
DARK
BARNWOOD

LIGHT SOURCE

LUMENS AND WATTAGE CHART

		24"	36"	48"	60"	89"
LED1	LUMENS DELIVERED	1120	1680	2240	2800	4080
	SYSTEM WATTAGE	14	21	28	35	51
LED2	LUMENS DELIVERED	1680	2480	3360	4160	6160
	SYSTEM WATTAGE	21	31	42	52	77

This chart was created for a 35K color temp. Multiply by 0.95 for 27k color temp, 0.97 for 30k color temp, and 1.03 for 40k color temp.

Values shown for 80+ CRI. For 90+ CRI lumens use 0.85 multiplier.

PHOTOMETRY:

FIXTURE: UA1-P1XX-24-LED1
 COLOR TEMP #: 3500K
 OUTPUT: 1120
 EFFICACY: 79 LM/W
 TEST REPORT: TEST NO. 17603.0

For all available IES files, please visit our website at ocl.com.

STANDARD COLOR TEMPERATURE OPTIONS

STANDARD COLOR TEMPERATURE OPTIONS	CRI (RA)	
2700K	80+	90+
3000K	80+	90+
3500K	80+	90+
4000K	80+	90+

For 80+ CRI - 80 RA, R9 > 0 (10-15 TYP.); For 90+ CRI - 90 RA, R9 > 50

ZONE	LUMENS	% OF LUMINAIRE
0-30	248	14%
0-60	666	38%
0-90	827	47%
90-180	933	53%
0-180	1760	100%

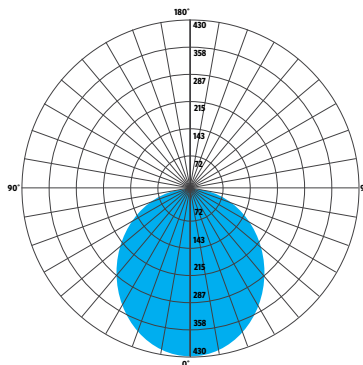

CONTROL

DM1 0-10V DIMMING 1%

- 0-10V DIMMING PROTOCOL
- 1% MINIMUM DIM LEVEL
- ELECTRONIC DRIVER
- POWER FACTOR >0.9
- THD <20%
- MINIMUM AMBIENT OPERATING TEMPERATURE -31°F
- FIELD REPLACEABLE

OPTIONS

ULD DAMP LABEL LUMINAIRE

- MAY BE USED IN AN OUTDOOR AREA THAT IS PROTECTED FROM DIRECT CONTACT WITH WIND, RAIN, SNOW OR EXCESSIVE MOISTURE

BIOS

- **BIOS SKYBLUE™ DYNAMIC** LIGHT ENGINE IS DIMMABLE AND FEATURES A SIMPLE APPROACH TO CIRCADIAN LIGHTING CONTROLS.
- WHEN PAIRED WITH THE BIOS BIO-DIMMING MODULE, IT OPERATES USING ANY SINGLE CHANNEL CONSTANT CURRENT (CC) LED DRIVER AND CAN BE USED WITH ANY STANDARD DIMMING INTERFACE/PROTOCOL (0-10V, ELV, DMX, WIRELESS) AND COULD WORK WITH EXISTING TWO-CHANNEL CONTROL SYSTEMS AS WELL.
- VISIT OCL.COM/BIOS FOR MORE INFORMATION

MOD MODIFIED LUMINAIRE

- LUMINAIRE IS MODIFIED FROM STANDARD OPTIONS; CONTACT LOCAL REP FOR MORE INFORMATION

SPECIFICATIONS

CONSTRUCTION

- HOUSING IS EXTRUDED AND WELDED ALUMINUM
- END CAPS ARE CAST ALUMINUM
- EXTRUDED DIFFUSER IS FROSTED WHITE ACRYLIC
- HARDWARE IS ZINC PLATED OR STAINLESS STEEL

MOUNTING

- **CINA** MOUNTS TO 4X4" OCTAGON OR 4" ROUND J-BOX (BY OTHERS)

ELECTRICAL

- DIMMING ELECTRONIC DRIVER(S), COMES STANDARD WITH 0-10V DOWN TO 1% [STATIC WHITE]
- OCL PROPRIETARY LED ARRAYS USE NICHIA 757 DIODES
- **FOR INTEGRAL DRIVERS:** LUMINAIRE CONNECTS TO BUILDING SUPPLY (120V-277V 50/60HZ)
- **FOR REMOTE DRIVERS:** LUMINAIRE WIRE LEADS ARE LOW-VOLTAGE. THE WIRES SHOULD BE CONNECTED TO OCL PROVIDED REMOTE DRIVER ENCLOSURE ONLY!

LISTING

- ETL LISTED TO UL1598 FOR INDOOR, DRY LOCATION (DAMP LOCATION OPTIONAL)

WARRANTY

- 5 YEAR; ALL ELECTRICAL COMPONENTS RETAIN THE MANUFACTURER'S WARRANTY

BUILD AMERICA, BUY AMERICA (BABA)

- THIS PRODUCT MEETS THE GUIDELINES FOR THE BUILD AMERICA, BUY AMERICA ACT. **SOME EXCLUSIONS APPLY.** FOR MORE INFORMATION AND A FULL LIST OF ELIGIBLE SKUS, VISIT OCL.COM/BABA

SUSTAINABILITY

- THIS PRODUCT MEETS THE MATERIAL RESTRICTIONS OF ARTICLE 4 OF THE **ROHS** DIRECTIVE (2011/65/EU), INCLUDING COMMISSION DELEGATED DIRECTIVE 2015/863
- **BIOS** LIGHTING CONTRIBUTES TOWARD THE CIRCADIAN LIGHTING DESIGN FEATURE 54 UNDER THE **WELL BUILDING STANDARD™ V1** AND FEATURE L03 UNDER THE **WELL BUILDING STANDARD V2**

COMMON MODIFICATIONS

WE'RE BUILT FOR OUT-OF-THE-BOX THINKERS.

Nearly 50% of OCL fixtures we manufacture have some type of modification. Here is a list of common modifications we frequently produce. **Please contact the factory for modifications specific to your fixture or project.**

Need some help? Simply send your questions to us at OCL-Quotes@ocl.com

- BIOS, TUNABLE WHITE, WARM-DIM, & RGBW LIGHT SOURCES
- SPECIFIC LUMEN OUTPUT
- MODIFIED CLUSTERS OR CONFIGURATIONS / MULTI-DROP CANOPIES
- VARIOUS SHAPES, ARCS, AND CURVES FOR LINEAR PROFILES AND RINGS
- CEILING OR SURFACE MOUNTING
- LARGE SCALE MODIFICATIONS
- RAL, PANTONE, BRAND-SPECIFIC, RETIRED OCL COLOR, OR CUSTOM FINISHES



- EMERGENCY BATTERY BACKUP OR INVERTER OPTIONS
- REMOTE DRIVERS / EXTENDED DISTANCE REMOTE DRIVERS
- DIMMING TO 0.1% (DIM TO DARK)
- NON-STANDARD SIZES OR LENGTHS
- NON-STANDARD CANOPY, BODY AND/OR CORD COLORS
- SEISMIC AND/OR ANTI-SWAY SYSTEMS
- RIGID STEMS
- MODIFIED OVERALL HEIGHTS (LONGER OR SHORTER OAH)
- UPLIGHT ADDITIONS
- LASER ETCHING, ENGRAVING, AND CUTOUTS

The drawings and specifications and ideas, designs and arrangements represented on these drawings are and shall remain the property of The Original Cast Lighting (OCL Architectural Lighting) and no part thereof shall be copied, disclosed, to others or used in conjunction with any work or project other than the specified project for which they have been prepared and developed, without written consent of OCL. Visual contact with these plans or specifications shall constitute conclusive evidence of acceptance of these restrictions. All specifications and information subject to change without notice.