



Glowstick™

PENDANT

FEATURES

- ELEGANT & CONTEMPORARY DESIGN WITH END LIT DIFFUSER
- EXCELLENT THERMAL MANAGEMENT IS ACHIEVED THROUGH AN EXTRUDED AND MACHINED ALUMINUM FIXTURE BODY
- FIXTURES CAN BE CLUSTERED TOGETHER TO CREATE LARGE SCALE INSTALLATIONS.
- AVAILABLE IN 80+ CRI AND 90+ CRI (R9>50)
- 3 STEP LED BINNING
- FIELD REPLACEABLE LEDS AND DRIVERS



CATALOG CODES

GS1	B	C	CR	E	LED1	UNV	H	I	J
SERIES	HANGING SYSTEM	SIZE	DIFFUSER	FINISH	LIGHT SOURCE	VOLTAGE	OAH	CONTROL	OPTIONS

SPECIFY CATALOG CODE													
A		B		C		D		E					
SERIES		HANGING SYSTEM		SIZE		DIFFUSER		FINISH					
 GS1 GLOWSTICK		PICF	PENDANT WITH SURFACE MOUNT CANOPY, SINGLE SILVER POWER CORD; MOUNTS TO 4X4 OCTAGON J-BOX (BY OTHERS)		14	CR	CLEAR ACRYLIC ROD		POWDER COAT FINISHES				
			PIFE	PENDANT WITH FLAT MATTE WHITE CANOPY, SINGLE SILVER POWER CORD; MOUNTS TO OCL RECESSED J-BOX (PROVIDED BY OCL)					18	BKP	BLACK	MWP	MATTE WHITE
									24	BMP	BRASS METALLIC	SGP	STEEL GRAY
									30	BNP	BRONZE	SMP	SILVER METALLIC
									36	BTP	BLACK TEXTURED	SWP	SKY WHITE
					GRP	GRAPHITE	WTP	WHITE TEXTURED					
					GLP	GOLDTASTIC							

F			G		H		I		J			
LIGHT SOURCE			VOLTAGE		OAH		CONTROL		OPTIONS			
LED OUTPUT LED1	COLOR TEMP (80+ CRI)	COLOR TEMP (90+ CRI)	UNV	120-277		48 100 144	DM1	0-10V DIMMING 1%		HCL	HEX CELL LOUVER	
	27K	927K						DM3	LUTRON HI-LUME ECOSYSTEM 1% (LDE1)		ULD	UL DAMP LABEL
	30K	930K							MOD		MODIFIED LUMINAIRE (CONTACT LOCAL REP)	
	35K	935K										
	40K	940K										

SAMPLE CODE: GS1-PICF-24-CR-WTP-LED1/35K-UNV-48-DM1

*For Minimum OAH, see hanging systems details. Fixture will ship with one of three standard OAH's (48", 100" or 144") field adjustable to the desired height.

UP TO **75** LM/W

		ALL SIZES
LED1	LUMENS DELIVERED	825
	SYSTEM WATTAGE	11

This chart was created for a 35K color temp. Multiply by 0.95 for 27k color temp, 0.97 for 30k color temp, and 1.03 for 40k color temp.

Values shown for 80+ CRI. For 90+ CRI lumens use 0.85 multiplier.

MODS, NOTES, & COMMENTS



This product meets the material restrictions of Article 4 of the RoHS Directive (2011/65/EU), including Commission Delegated Directive 2015/863

HANGING SYSTEM

PICF PENDANT WITH SURFACE MOUNT CANOPY, SINGLE **SILVER** POWER CORD; MOUNTS TO 4X4 OCTAGON J-BOX (BY OTHERS)

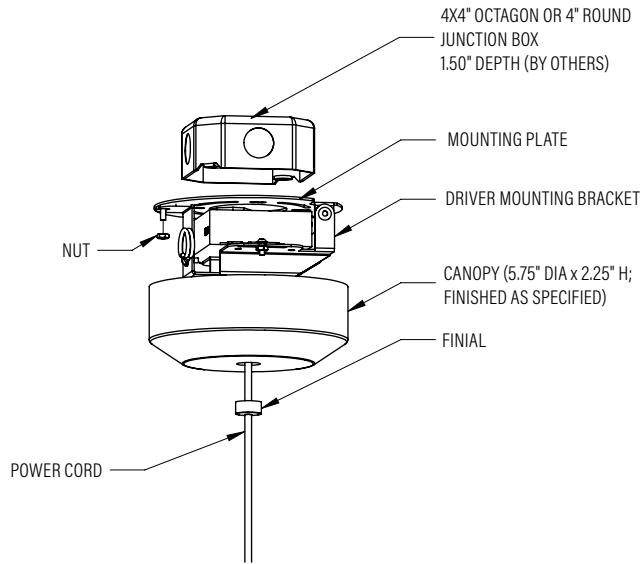

MOUNTING INFORMATION CHART

FIXTURE LENGTH	FIXTURE WEIGHT	MIN/MAX OAH
14"	4 LBS	20/120"
18"	4 LBS	24/120"
24"	5 LBS	30/120"
30"	5 LBS	36/120"
36"	5 LBS	42/120"

Fixture will ship with one of three standard OAH's (48", 100" or 144") field adjustable to the desired height.

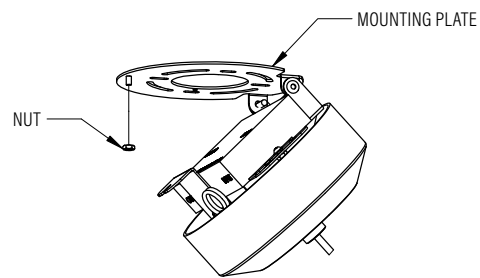

PIFE PENDANT WITH FLAT MATTE WHITE CANOPY, SINGLE **SILVER** POWER CORD; MOUNTS TO OCL RECESSED J-BOX (PROVIDED BY OCL)

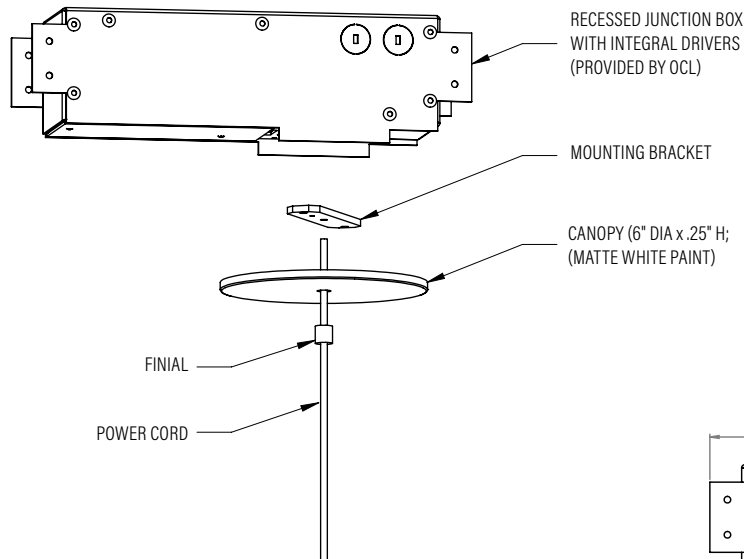

MOUNTING INFORMATION CHART

FIXTURE LENGTH	FIXTURE WEIGHT	MIN/MAX OAH
14"	4 LBS	17/120"
18"	4 LBS	21/120"
24"	5 LBS	27/120"
30"	5 LBS	33/120"
36"	5 LBS	39/120"

Fixture will ship with one of three standard OAH's (48", 100" or 144") field adjustable to the desired height.

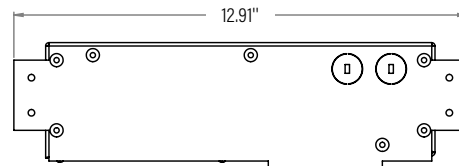
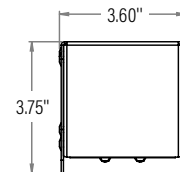

PROFILE VIEW
RECESSED JUNCTION BOX

SIZE AND SECTIONS

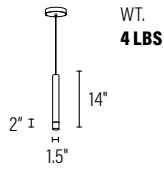

WT.
4 LBS

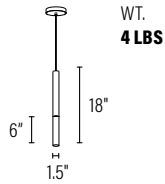

WT.
4 LBS

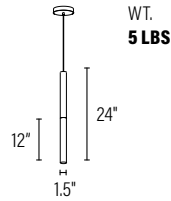

WT.
5 LBS

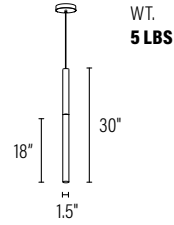

WT.
5 LBS

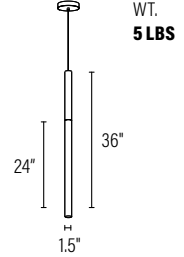

WT.
5 LBS

DIFFUSER

ACRYLIC FINISHES:



CR CLEAR ACRYLIC ROD

METALLIC POWDER COAT FINISHES:



SMP
SILVER



GRP
GRAPHITE



SGP
STEEL GRAY



GLP
GOLD



BMP
BRASS



BNP
BRONZE

SOLID POWDER COAT FINISHES:



SWP
SKY WHITE



MWP
MATTE
WHITE



BKP
BLACK

TEXTURED POWDER COAT FINISHES:



BTP
BLACK
TEXTURED



WTP
WHITE
TEXTURED

RAL, Pantone® or custom finishes are also available.

These colors are for reference only. Please be aware that colors may vary per monitor. Contact your local rep for finish samples or with any questions.

LIGHT SOURCE

		ALL SIZES
LED1	LUMENS DELIVERED	825
	SYSTEM WATTAGE	11

This chart was created for a 35K color temp. Multiply by 0.95 for 27k color temp, 0.97 for 30k color temp, and 1.03 for 40k color temp.

Values shown for 80+ CRI. For 90+ CRI lumens use 0.85 multiplier.

PHOTOMETRY:

LUMINAIRE: GS1-P1CB-24-CR-PTD-LED1/35K-UNV
 COLOR TEMP #: 3500K
 EFFICACY: 75 LM/W
 TEST REPORT: TEST NO. 18917.0

For all available IES files, please visit our website at ocl.com.

STANDARD COLOR TEMPERATURE OPTIONS	CRI (RA)	
	2700K	80+
3000K	80+	90+
3500K	80+	90+
4000K	80+	90+

LUMEN MAINTENANCE

REPORTED: L70 AT >60,000 HRS
 CALCULATED: L70 AT 140,000 HRS
 REPORTED: L90 AT 42,000 HRS
 CALCULATED: L90 AT 42,000 HRS

Derived from EPA TM-21 calculator. Based on typical conditions. Consult the factory for additional details

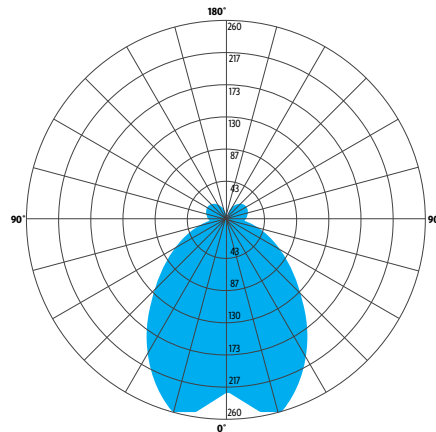

ZONE	LUMENS	% OF LUMINAIRE
0-30	215	26%
0-60	520	63%
0-90	655	79%
90-180	175	21%
0-180	825	100%

CONTROL

DM1 0-10V DIMMING 1%

- 0-10V DIMMING
- 1% MINIMUM DIM LEVEL
- ELECTRONIC DRIVER
- POWER FACTOR >0.9
- THD <20%
- MINIMUM AMBIENT OPERATING TEMPERATURE -31°F
- FIELD REPLACEABLE

DM3 LUTRON HI-LUME ECOSYSTEM 1% (LDE1)

- LUTRON DIGITAL ECOSYSTEM DIMMING
- 1% MINIMUM DIMMING LEVEL
- SOFT-ON / FADE-TO-BLACK
- ELECTRONIC DRIVER
- POWER FACTOR >0.9 @ 120V
- THD <23% @ 120V
- MIN AMBIENT OPERATING TEMPERATURE = -32°F
- FIELD REPLACEABLE

OPTIONS

HCL HEX CELL LOUVER

- PROVIDES A 45° VISUAL CUT-OFF TO HELP REDUCE GLARE

ULD DAMP LABEL LUMINAIRE

- MAY BE USED IN AN OUTDOOR AREA THAT IS PROTECTED FROM DIRECT CONTACT WITH WIND, RAIN, SNOW OR EXCESSIVE MOISTURE

MOD MODIFIED LUMINAIRE

- LUMINAIRE IS MODIFIED FROM STANDARD OPTIONS; CONTACT LOCAL REP FOR MORE INFORMATION

SPECIFICATIONS

CONSTRUCTION

- HOUSING IS EXTRUDED AND MACHINED ALUMINUM
- DIFFUSER IS CLEAR ACRYLIC
- CANOPY IS SPUN ALUMINUM
- HARDWARE IS ZINC PLATED OR STAINLESS STEEL

MOUNTING

- P1CF MOUNTS TO 4X4" OCTAGON OR 4" ROUND J-BOX (BY OTHER)
- P1FE MOUNTS TO OCL PROPRIETARY RECESSED J-BOX WITH INTEGRAL DRIVER (PROVIDED BY OCL)

ELECTRICAL

- DIMMING ELECTRONIC DRIVER(S), COMES STANDARD WITH 0-10V DOWN TO 1%
- LUTRON (LDE1) ECOSYSTEM 1% ALSO AVAILABLE
- BRIDGELUX COB
- 80+ CRI = 80 RA, R9 > 0 (10-15 TYP)
- 90+ CRI = 90 RA, R9 > 50
- LUMINAIRE CONNECTS TO BUILDING SUPPLY (120V-277V 50/60HZ) UNLESS DRIVERS ARE REMOTE

LISTING

- ETL LISTED TO UL 1598 FOR DRY LOCATIONS; DAMP LOCATION LISTED IS OPTION

WARRANTY

- 5 YEAR; ALL ELECTRICAL COMPONENTS RETAIN THE MANUFACTURER'S WARRANTY

SUSTAINABILITY

- THIS PRODUCT MEETS THE MATERIAL RESTRICTIONS OF ARTICLE 4 OF THE **ROHS** DIRECTIVE (2011/65/EU), INCLUDING COMMISSION DELEGATED DIRECTIVE 2015/863

The drawings and specifications and ideas, designs and arrangements represented on these drawings are and shall remain the property of The Original Cast Lighting (OCL Architectural Lighting) and no part thereof shall be copied, disclosed, to others or used in conjunction with any work or project other than the specified project for which they have been prepared and developed, without written consent of OCL. Visual contact with these plans or specifications shall constitute conclusive evidence of acceptance of these restrictions. All specifications and information subject to change without notice.